

SK9822

SPECIFICATION

INTEGRATED LIGHT SOURCE INTELLIGENT CONTROL (Double line transmission) OF CHIP-ON-TOP SMD TYPE LED

Document No.: JX/ SK9822

Model No.: SK9822

Description: 5.5x5.0x1.6mm Top SMD Type 0.2Watt Power Double
line transmission tegrated light source Intelligent control LED

Rev. No.: 01

Date: 2016-03-18

正式规格书



INTEGRATED LIGHT SOURCE INTELLIGENT CONTROL (Double line transmission) OF CHIP-ON-TOP SMD TYPE LED

Model: SK9822

1. Product Overview :

SK9822 is a two-wire transmission channel three (RGB) driving intelligent control circuit and the light emitting circuit in one of the LED light source control. Products containing a signal decoding module, data buffer, a built-in constant current circuit and RC oscillator; CMOS, low voltage, low power consumption; 256 level grayscale PWM adjustment and 32 brightness adjustment; use the double output, Data and synchronization of the CLK signal, connected in series each wafer output action synchronization.

2. Main Application Field:

- Full color LED string light, LED full color module, LED super hard and soft lights, LED guardrail tube, LED appearance / scene lighting
- LED point light, LED pixel screen, LED shaped screen, a variety of electronic products, electrical equipment etc..

3. Description:

- Top SMD internal integrated high quality external control line serial cascade constant current IC; 5V application; default on electric lights;
- Control circuit and the RGB chip in SMD 5050 components, to form a complete control of pixel, color mixing uniformity and consistency;
- The two-wire synchronous control.
- The three RGB output control, 8Bit (256) color; 5Bit (32) to adjust the brightness;
- The three constant current drive, self detection function specific signal
- The maximum frequency of 30MHZ serial data input
- The double data transmission, built-in support uninterrupted oscillation PWM output, can maintain a static image.

4. Mechanical Dimensions:

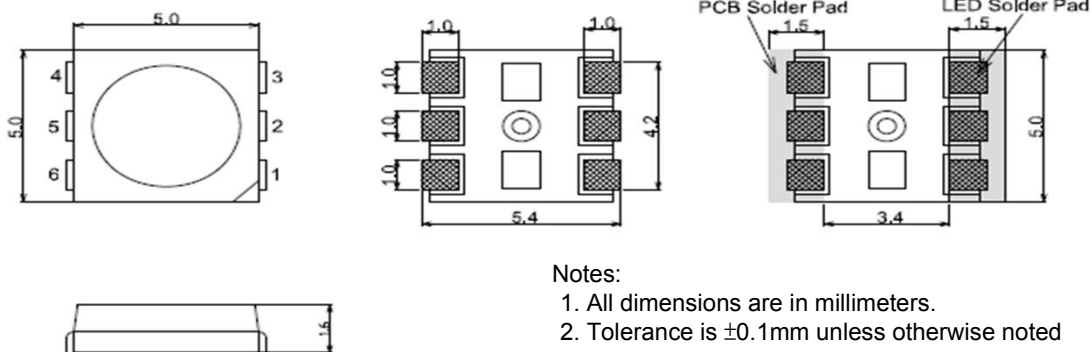

5. PIN configuration

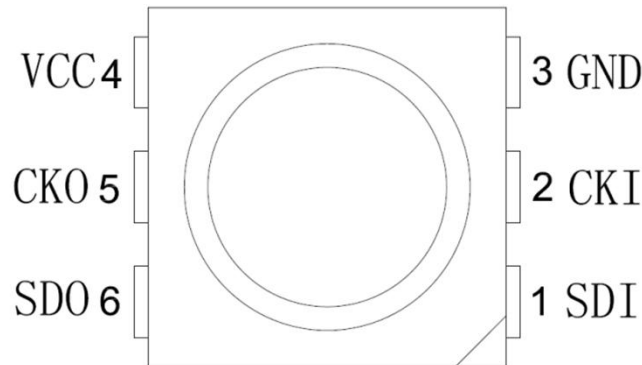

Item	Symbol	Pin Name	Function description
1	SDI	Data Input	control signal Input data
2	CKI	CLK Input	control signal Input Clock data
3	GND	Ground	The signal and power supply and grounding
4	VCC	Power	power supply pin
5	CKO	CLK Output	control signal output Clock data
6	SDO	Data Input	control signal output data

6. General Information

SK9822

SK9822: The default is RGB chips with IC integration

Jercio (Shenzhen) Technology Co., Ltd.

4th.Floor 2 Building NanFeng Industrial Zone Business Road No.11 ShiLong Community Shivan Street

Baoan District City ShenZhen TEL:0755-27863413 FAX:0755-27863413

7. Absolute Maximum Ratings (Ta=25°C, VSS=0V) :

Parameter	Symbol	Range	Unit
Power supply voltage	VDD	-0.5~+5.5	V
Logic input voltage	V_{IN}	-0.3~VDD+0.3	V
Working temperature	Topt	-20~+80	°C
Storage temperature	Tstg	-50~+120	°C
ESD pressure	V_{ESD}	4K	V

8. The electrical parameters (unless otherwise specified, TA=-20 ~ +70 °C, VDD=4.5 ~ 5.5V, VSS=0V):

Parameter	Symbol	Min	Typical	Max	Unit	Test conditions
The chip supply voltage	VDD	---	5.0	5.3	V	---
R/G/B port pressure	VDS,MAX	---	---	17	V	---
The biggest LED output current	I_{max}	---	---	20	mA	---
The clock high level width	TCLKH	---	---	>30	ns	---
The clock low level width	TCLKL	---	---	>30	ns	---
Data set up time	TSETUP	---	---	>10	ns	---
The frequency of PWM	FPWM	---	1.2	---	KHZ	---
Static power consumption	IDD	---	1	---	mA	---

9. Feature Descriptions:

(1) Series data structure

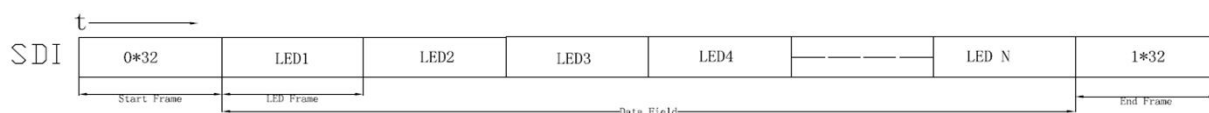

Start Frame 32 Bits

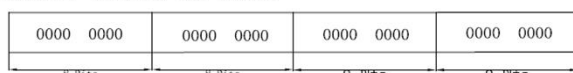

LED Frame 32 Bits

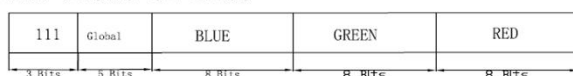

End Frame 32 Bits

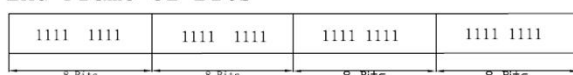

Jercio (Shenzhen) Technology Co., Ltd.

4th.Floor 2 Building NanFeng Industrial Zone Business Road No.11 ShiLong Community Shiyan Street

Baoan District City ShenZhen TEL:0755-27863413 FAX:0755-27863413

(2) 256 level gray level:

Data	Duty Cycle
MSB.....LSB	
0000 0000	0/256
0000 0001	1/256
0000 0010	2/256
-	-
-	-
-	-
-	-
1111 1101	253/256
1111 1110	254/256
1111 1111	255/256

(3) PWM input / output signal relationship:

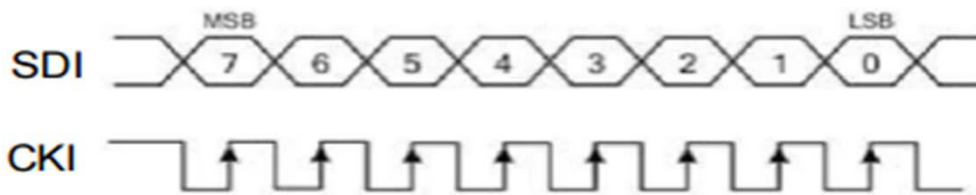

(4) 5-Bit (level 32) brightness adjustment (simultaneous control of OTR\OUTG\OUTB three port current):

Data	Driving Current
MSB.....LSB	
00000	0/31
00001	1/31
00010	2/31
-	-
-	-
-	-
-	-
11101	29/31
11110	30/31
11111	31/31

(5) Refresh Rate :

Frame rate (=1/ (64+ (32* points)) *CKI (cycle) unit:
frames per second)

Such as: 1024 points, CKI frequency is 1MHZ, is =30
frames per second frame rate.

10. The typical application circuit:

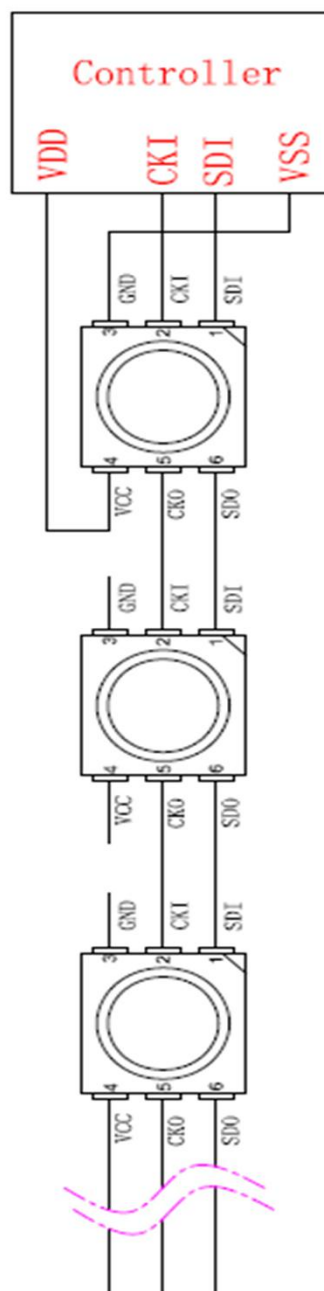

11. Standard LED Performance Graph:

Typical Relative Luminous Flux vs. Forward Current

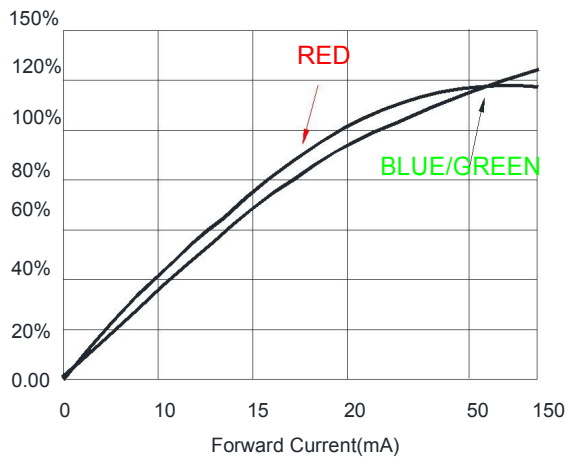

Forward Voltage vs. Forward Current

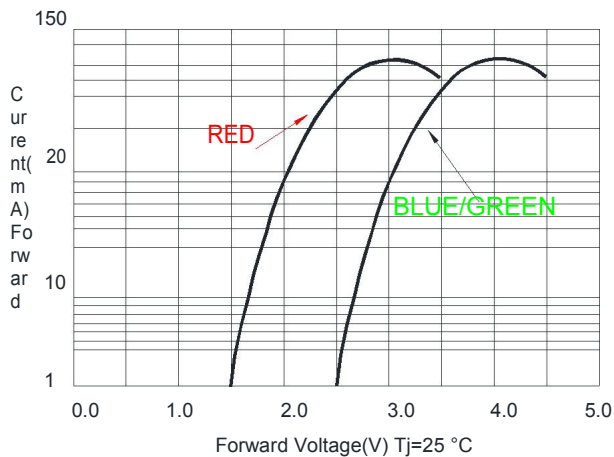

Thermal Pad Temperature vs. Relative Light Output

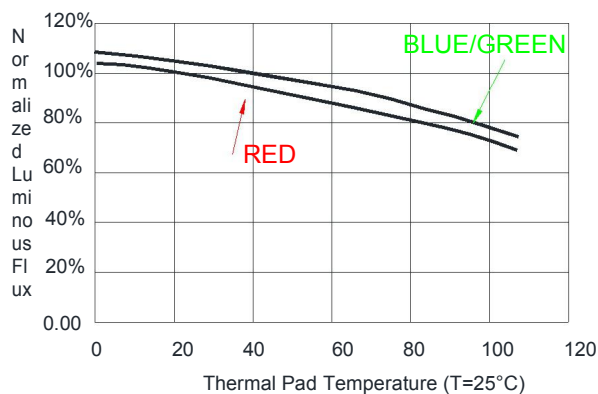

Wavelength Characteristics

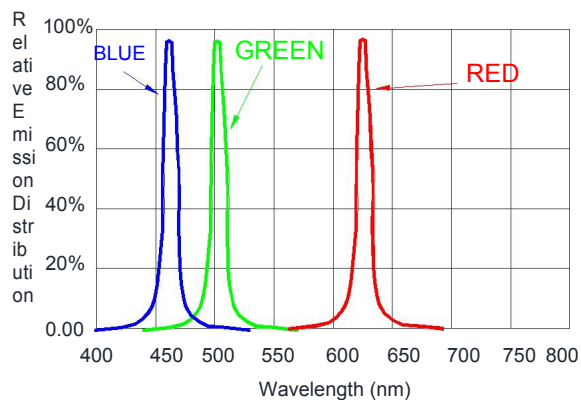

Thermal Pad Temperature vs. Forward Current

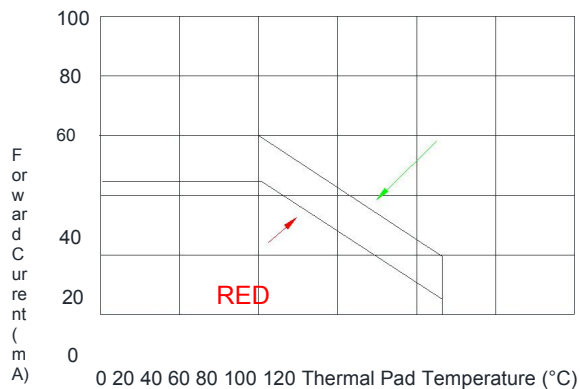

Typical Radiation Pattern 120°

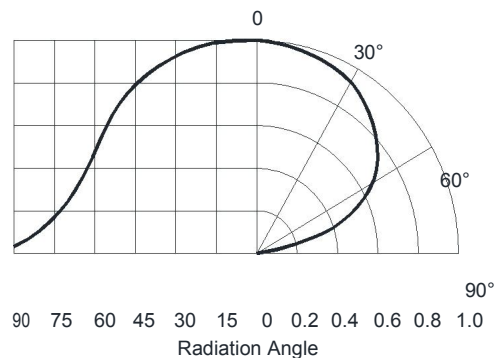

12. Packaging Standard:

S K 9822

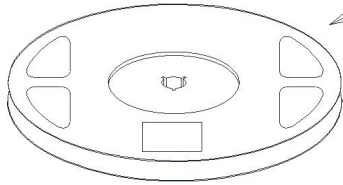
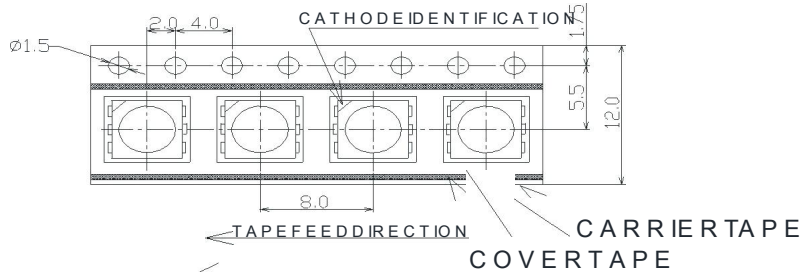

REEL (178x12m m)
(INNER 1000pcs LED MAX)

ESD POLYETHYLENE BAG

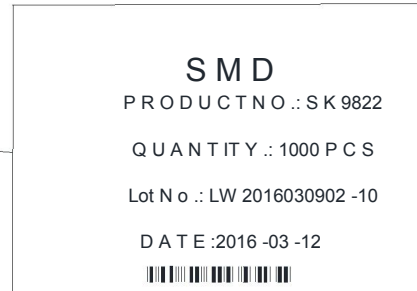
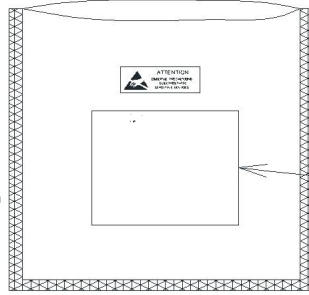

LABEL SKETCHING

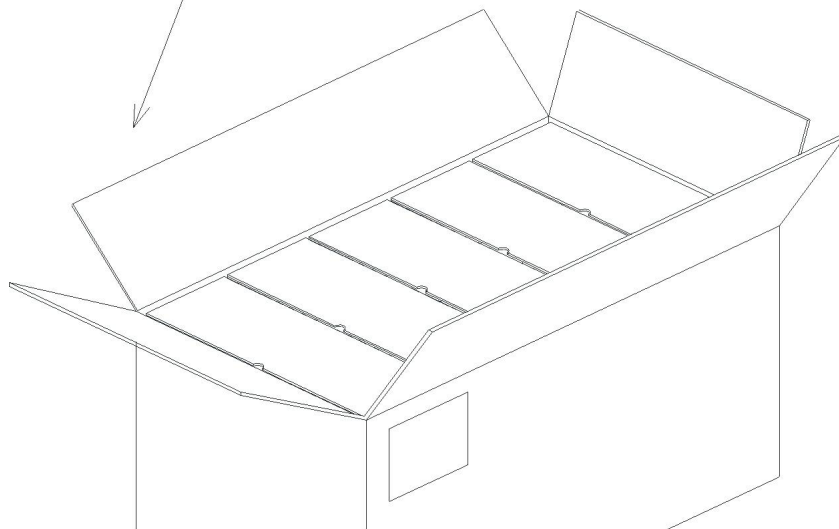

CARDBOARD (INNER 40 BAG MAX.)

The reel pack is applied in SMD LED. The LEDs are packed in cardboard boxes after packaging in normal or anti-electrostatic bags. cardboard boxes will be used to protect the LEDs from mechanical shocks during transportation. The boxes are not water resistant and therefore must be kept away from water and moisture.

TOP SMD LED Application Notes

3.1.1. Features

The Purposes of making The customers and users to have a clear understanding on the ways how to use the LED.

3.2.2. Description

Generally. The LED can be used the same way as other general purposed semiconductors. When using The TOP SMD LED, the following precautions must be taken to protect the LED.

3.3.Cautions

3.4.Dust & Cleaning

This emitter has a silicone surface, There are many benefits to the silicone surface in terms of optical properties and improved reliability. However, silicone is a softer material and prone to attract dust. While a minimal amount of dust and debris on the LED will not cause significant reduction in illumination, steps should be taken to keep the emitter free of dust.

These include keeping the LEDs in the manufacturer's package prior to assembly and storing assemblies in an enclosed area after installing the emitters.

Surface condition of this device may change when organic solvents such as trichloroethylene or acetone were applied.

Avoid using organic solvent, it is recommended that isopropyl be used as a solvent for cleaning the LEDs. When using other solvents, it should be confirmed beforehand whether the solvents will dissolve the package and the resin of not.

Do not clean the LEDs by the ultrasonic. When it is absolutely necessary, the influence as ultrasonic cleaning on the LEDs depends on factors such as ultrasonic power. Baking time and assembled condition. Before cleaning, a pre-test should be done to confirm whether any damage to the LEDs will occur.

3.2. Moisture Proof Package

In order to avoid the absorption of moisture during transportation and storage, LED are packed in the aluminum envelop, A desiccant is included in the aluminum envelop as it absorbs moisture. When moisture is absorbed into the AMT package it may vaporize and expand during soldering. There is a possibility that this can cause exfoliation of the contacts and damage to the optical characteristics of the LEDs. For this reason, the moisture proof package is used to keep moisture to a minimum in the package.

3.3. Storage

In order to avoid the absorption of moisture, It is recommended to store SMD LED (in bulk or taped) in the dry box (or the desiccator) with a desiccant, Otherwise to store them in the following environment as recommended.

a. Temperature: 5°C~30°C

b. Humidity: 60% RH Max

It is recommended to solder the LED as soon as possible after unpacking the aluminum envelop, But in case that the LED have to be left unused after unpacking envelop again is requested.

The LED should be soldering within 1 hours after opening the package.

If baking is required, A baking treatment should be performed as follows:

70°C±5°C for more than 24 hours.

3.4. Reflow Soldering Characteristics

In testing, Has found S50 LEDs to be compatible with JEDEC J-STD-020C, using the parameters listed below. As a general guideline the recommends that users follow the recommended soldering profile provided by the manufacturer of solder paste used.

Note that this general guideline is offered as a starting point and may require adjustment for certain PCB designs and Configurations of reflow soldering equipment.

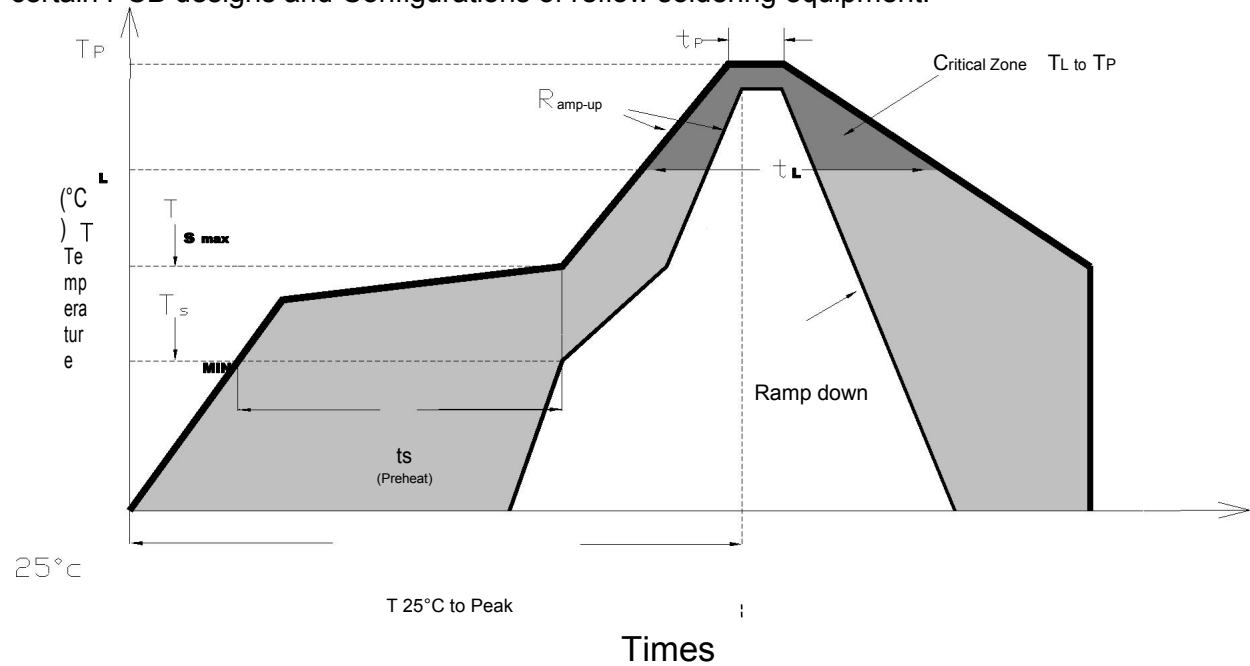

Profile Feature	Lead-Based Solder	Lead-Free Solder
Average Ramp-Up Rate (Ts max to Tp)	3°C/second max.	3°C/second max.
Preheat: Temperature Min (Ts min)	100°C	150°C
Preheat: Temperature Min (Ts max)	150°C	200°C
Preheat: Time (ts min to ts max)	60-120 seconds	60-180 seconds
Time Maintained Above: Temperature (TL)	183 °C	217 °C
Time Maintained Above: Time (t L)	60-150 seconds	60-150 seconds
Peak/Classification Temperature (T P)	215 °C	240 °C
Time Within 5°C of Actual Peak Temperature (tp)	<10 seconds	<10 seconds
Ramp-Down Rate	6°C/second max.	6°C/second max.
Time 25 °C to Peak Temperature	<6 minutes max.	<6 minutes max.

Note: All temperatures refer to topside of the package, measured on the package body surface.

3.5 Heat Generation:

Thermal design of the end product is of paramount importance. Please consider the heat generation of the LED when making the system design. The coefficient of temperature increase per input electric power is affected by the thermal resistance of the circuit board and density of LED placement on the board, as well as components. It is necessary to avoid intense heat generation and operate within the maximum rating given in this specification. The operating current should be decided after considering the ambient maximum temperature of LEDs

3.6 Electrostatic Discharge & Surge Current :

Electrostatic discharge (ESD) or surge current (EOS) may damage LED.

Precautions such as ESD wrist strap, ESD shoe strap or antistatic gloves must be worn whenever handling of LED.

All devices, equipment and machinery must be properly grounded.

It is recommended to perform electrical test to screen out ESD failures at final inspection. It is important to eliminate the possibility of surge current during circuitry design.

3.7 Moisture Proof Package

Cannot take any responsibility for any trouble that are caused by using the LEDs at conditions exceeding our specifications.

The LED light output is strong enough to injure human eyes. Precautions must be taken to prevent looking directly at the LEDs with unaided eyes for more than a few seconds.

The formal specification must be exchanged and signed by both parties before large volume purchase begins. The appearance and specifications of the product may be modified for improvement without notice.

Change History

FCN No.	Date	Rev. No.	Changes/Reason of changes
	2016-03-18	01	Initial Document

Items	Signatures	Date	Note
Prepared by	Kevin Zhu	2016-03-18	
Checked by			
Approved by			
FCN#			